

TGS 813 - for the detection of Combustible Gases

Features:

- * General purpose sensor with sensitivity to a wide range of combustible gases
- * High sensitivity to methane, propane, and butane
- * Long life and low cost
- * Uses simple electrical circuit

Applications:

- * Domestic gas leak detectors and alarms
- * Portable gas detectors

The sensing element of Figaro gas sensors is a tin dioxide (SnO_2) semiconductor which has low conductivity in clean air. In the presence of a detectable gas, the sensor's conductivity increases depending on the gas concentration in the air. A simple electrical circuit can convert the change in conductivity to an output signal which corresponds to the gas concentration.

The **TGS 813** has high sensitivity to methane, propane, and butane, making it ideal for natural gas and LPG monitoring. The sensor can detect a wide range of gases, making it an excellent, low cost sensor for a wide variety of applications. Also available with a ceramic base which is highly resistant to severe environments up to 200°C (model# TGS 816).



The figure below represents typical sensitivity characteristics, all data having been gathered at standard test conditions (see reverse side of this sheet). The Y-axis is indicated as *sensor resistance ratio* (R_s/R_o) which is defined as follows:

- R_s = Sensor resistance of displayed gases at various concentrations
- R_o = Sensor resistance in 1000ppm methane

The figure below represents typical temperature and humidity dependency characteristics. Again, the Y-axis is indicated as *sensor resistance ratio* (R_s/R_o), defined as follows:

- R_s = Sensor resistance at 1000ppm of methane at various temperatures/humidities
- R_o = Sensor resistance at 1000ppm of methane at 20°C and 65% R.H.

Sensitivity Characteristics:

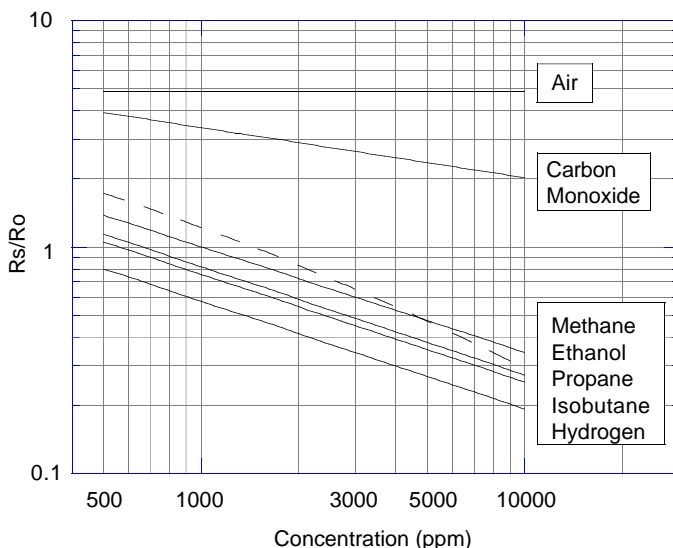

Temperature/Humidity Dependency:

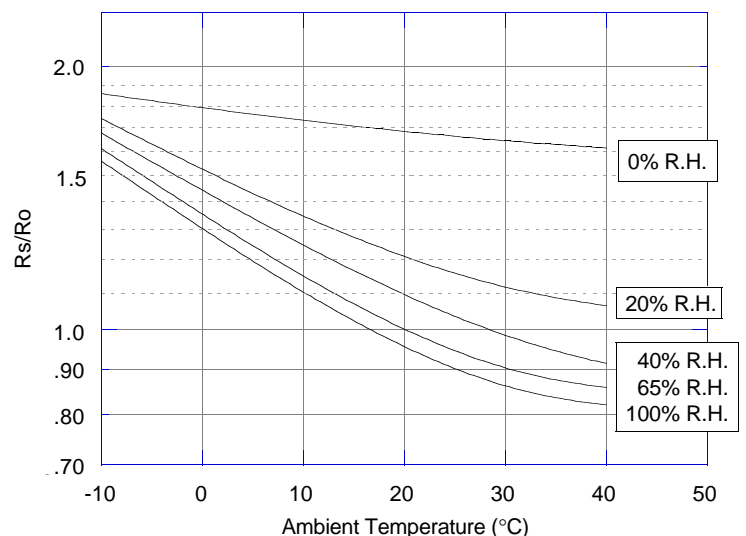

IMPORTANT NOTE: OPERATING CONDITIONS IN WHICH FIGARO SENSORS ARE USED WILL VARY WITH EACH CUSTOMER'S SPECIFIC APPLICATIONS. FIGARO STRONGLY RECOMMENDS CONSULTING OUR TECHNICAL STAFF BEFORE DEPLOYING FIGARO SENSORS IN YOUR APPLICATION AND, IN PARTICULAR, WHEN CUSTOMER'S TARGET GASES ARE NOT LISTED HEREIN. FIGARO CANNOT ASSUME ANY RESPONSIBILITY FOR ANY USE OF ITS SENSORS IN A PRODUCT OR APPLICATION FOR WHICH SENSOR HAS NOT BEEN SPECIFICALLY TESTED BY FIGARO.

FIGARO
 an ISO9001 company



Technical Information for Combustible Gas Sensors

Figaro TGS 8-series sensors are a type of sintered bulk metal oxide semiconductor which offer low cost, long life, and good sensitivity to target gases while utilizing a simple electrical circuit. The TGS813 displays high selectivity and sensitivity to LP Gas and methane.



	<i>Page</i>
<i>Specifications</i>	
Features	2
Applications	2
Structure	2
Basic measuring circuit	2
Circuit & operating conditions	3
Specifications	3
Dimensions	3
 <i>Basic Sensitivity Characteristics</i>	
Sensitivity to various gases	4
Temperature and humidity dependency	5
Heater voltage dependency	6
Gas response	6
Initial action	7
Long term characteristics	7

See also Technical Brochure 'Technical Information on Usage of TGS Sensors for Toxic and Explosive Gas Leak Detectors'.

IMPORTANT NOTE: OPERATING CONDITIONS IN WHICH FIGARO SENSORS ARE USED WILL VARY WITH EACH CUSTOMER'S SPECIFIC APPLICATIONS. FIGARO STRONGLY RECOMMENDS CONSULTING OUR TECHNICAL STAFF BEFORE DEPLOYING FIGARO SENSORS IN YOUR APPLICATION AND, IN PARTICULAR, WHEN CUSTOMER'S TARGET GASES ARE NOT LISTED HEREIN. FIGARO CANNOT ASSUME ANY RESPONSIBILITY FOR ANY USE OF ITS SENSORS IN A PRODUCT OR APPLICATION FOR WHICH SENSOR HAS NOT BEEN SPECIFICALLY TESTED BY FIGARO.

1. Specifications

1-1 Features

- * General purpose sensor for a wide range of combustible gases
- * High sensitivity to LP gas and methane
- * Low cost
- * Long life
- * Uses simple electrical circuit

1-2 Applications

- * Domestic gas leak detectors and alarms
- * Recreational vehicle gas leak detectors
- * Portable gas detectors

1-3 Structure

Figure 1 shows the structure of TGS813. This sensor is a sintered bulk semiconductor composed mainly of tin dioxide (SnO₂). The semiconductor material and electrodes are formed on an alumina ceramic tube. A heater coil, made of 60 micron diameter wire, is located inside the ceramic tube. Lead wires from the sensor electrodes are a gold alloy of 80 microns in diameter. Heater and lead wires are spotwelded to the sensor pins which have been arranged to fit a 7-pin miniature tube socket.

The sensor base and cover are made of Nylon 66, conforming to UL 94HB (Authorized Material Standard). The deformation temperature for this material is in excess of 240°C. The upper and lower openings in the sensor case are covered with a flameproof double layer of 100 mesh stainless steel gauze (SUS316). Independent tests confirm that this mesh will prevent a spark produced inside the flameproof cover from igniting an explosive 2:1 mixture of hydrogen/oxygen.

1-4 Basic measuring circuit

Figure 2 shows the basic measuring circuit for use with TGS813. Circuit voltage (V_c) is applied across the sensor element which has a resistance between the sensor's two electrodes and the load resistor (R_L) connected in series. The sensor signal (V_{RL}) is measured indirectly as a change in voltage across the R_L. The R_s is obtained from the formula shown at the right.

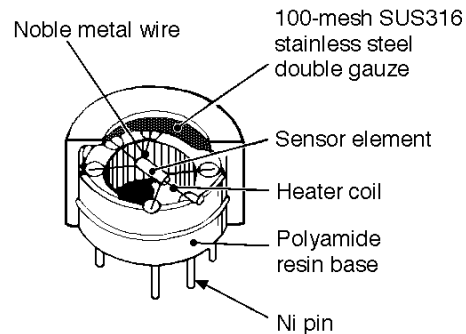

Sensor element

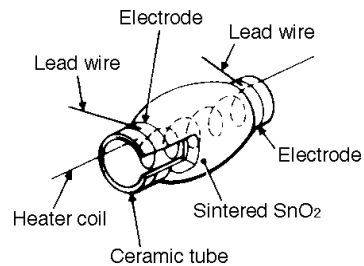

Fig. 1 - Sensor structure

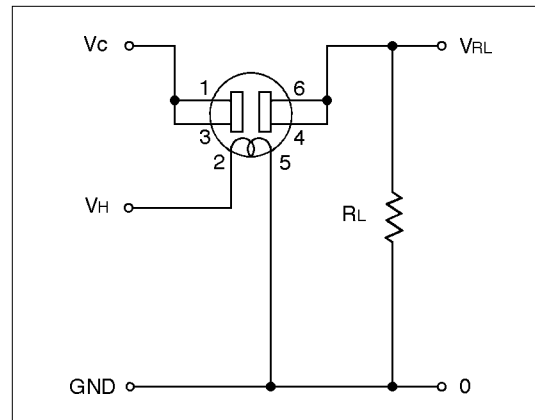

Fig. 2 - Basic measuring circuit

$$R_s = \frac{V_c - V_{RL}}{V_{RL}} \times R_L$$

Formula to determine R_s

1-5 Circuit & operating conditions

The ratings shown below should be maintained at all times to insure stable sensor performance:

Item	Specification
Circuit voltage (Vc)	Max. 24V AC/DC
Heater voltage (VH)	5.0V ± 0.2V AC/DC
Heater resistance (room temp.)	30 ± 3Ω
Load resistance (RL)	Variable (min = [Vc ² /60]kΩ)
Sensor power dissipation (Ps)	≤ 15mW
Operating & storage temperature	-40°C ~ +70°C
Optimal detection concentration	500 ~ 10,000ppm

1-6 Specifications NOTE 1

Item	Specification
Sensor resistance (1000ppm methane)	5kΩ ~ 15kΩ
Sensor resistance ratio (Rs/Ro)	0.60 ± 0.05
Rs/Ro = Rs(3000ppm methane)/Rs(1000ppm methane)	
Heater current (RH)	approx. 167mA
Heater power consumption (PH)	approx. 835mW

Mechanical Strength:

The sensor shall have no abnormal findings in its structure and shall satisfy the above electrical specifications after the following performance tests:

Withdrawal Force - withstand force > 5kg in each direction

Vibration - frequency-1000c/min., total amplitude-4mm, duration-one hour, direction-vertical

Shock - acceleration-100G, repeated 5 times

1-7 Dimensions

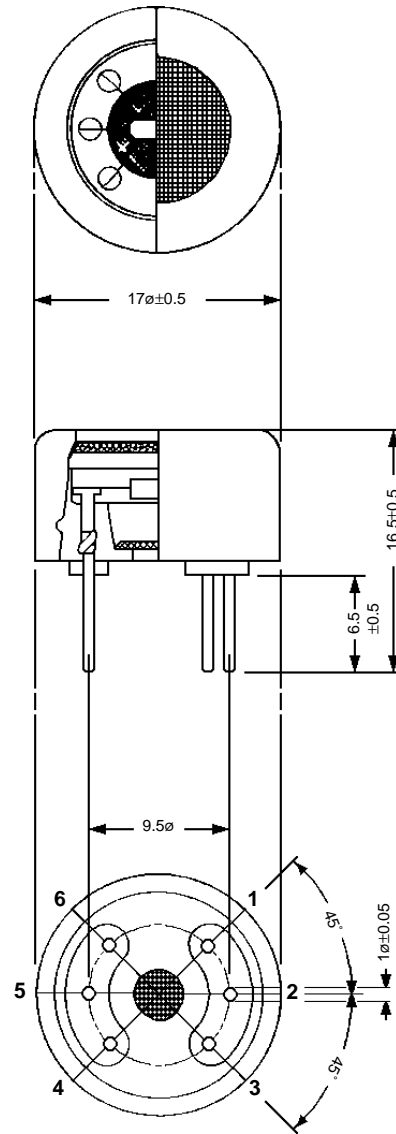

Fig. 3 - Sensor dimensions

NOTE 1: Sensitivity characteristics are obtained under the following standard test conditions:

(Standard test conditions)

Temperature and humidity: 20 ± 2°C, 65 ± 5% RH

Circuit conditions: Vc = 10.0 ± 0.1V AC/DC

VH = 5.0 ± 0.05V AC/DC

RL = 4.0kΩ ± 1%

Preheating period: 7 days or more under standard circuit conditions

2. Basic Sensitivity Characteristics

2-1 Sensitivity to various gases

Figure 4 shows the relative sensitivity of TGS813 to various gases. The Y-axis shows the ratio of the sensor resistance in various gases (R_s) to the sensor resistance in 1000ppm of methane (R_o).

Using the basic measuring circuit illustrated in Figure 2, these sensitivity characteristics provide the sensor output voltage (V_{RL}) change as shown in Figure 5.

NOTE:

All sensor characteristics in this technical brochure represent typical sensor characteristics. Since the R_s or output voltage curve varies from sensor to sensor, calibration is required for each sensor (for additional information on calibration, please refer to the Technical Advisory 'Technical Information on Usage of TGS Sensors for Toxic and Explosive Gas Leak Detectors').

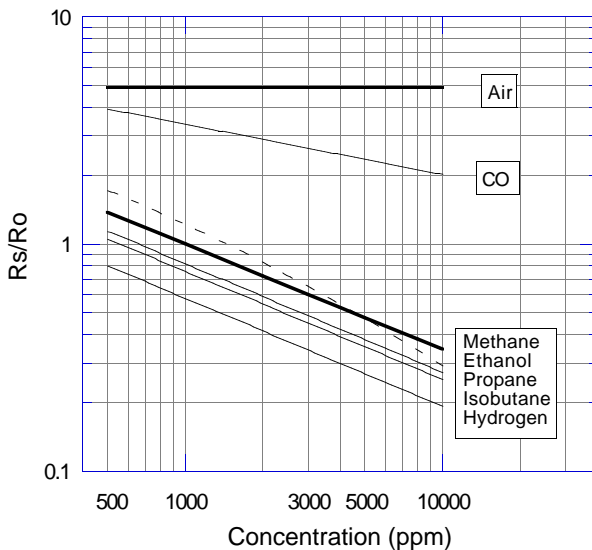

Fig. 4 - Sensitivity to various gases (R_s/R_o)

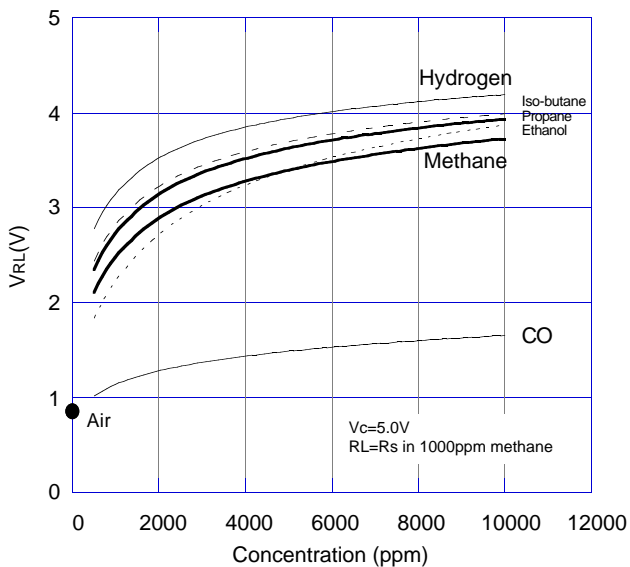

Fig. 5 - Sensitivity to various gases (V_{RL})

2-2 Temperature and humidity dependency

Figure 6 shows the temperature and humidity dependency of TGS813. The Y-axis shows the ratio of sensor resistance in 1000ppm of methane under various atmospheric conditions (R_s) to the sensor resistance in 1000ppm of methane at 20°C/65%RH (R_o).

R.H. (°C)	0%R.H.	20%R.H.	40%R.H.	65%R.H.	100%R.H.
-10	1.860	1.742	1.676	1.609	1.556
0	1.792	1.523	1.441	1.353	1.303
10	1.733	1.346	1.247	1.150	1.102
20	1.684	1.211	1.095	1.000	0.955
30	1.643	1.117	0.984	0.903	0.861
40	1.612	1.065	0.914	0.858	0.820

Table 1 - Temperature and humidity dependency (typical values of R_s/R_o for Fig. 6)

Table 1 shows a chart of values of the sensor's resistance ratio (R_s/R_o) under the same conditions as those used to generate Figure 6.

Figure 7 shows the sensitivity curve for TGS813 to methane under several ambient conditions. While temperature may have a large influence on absolute R_s values, this chart illustrates the fact that effect on the slope of sensor resistance ratio (R_s/R_o) is not significant. As a result, the effects of temperature on the sensor can easily be compensated.

For economical circuit design, a thermistor can be incorporated to compensate for temperature (for additional information on temperature compensation in circuit designs, please refer to the Technical Advisory 'Technical Information on Usage of TGS Sensors for Toxic and Explosive Gas Leak Detectors').

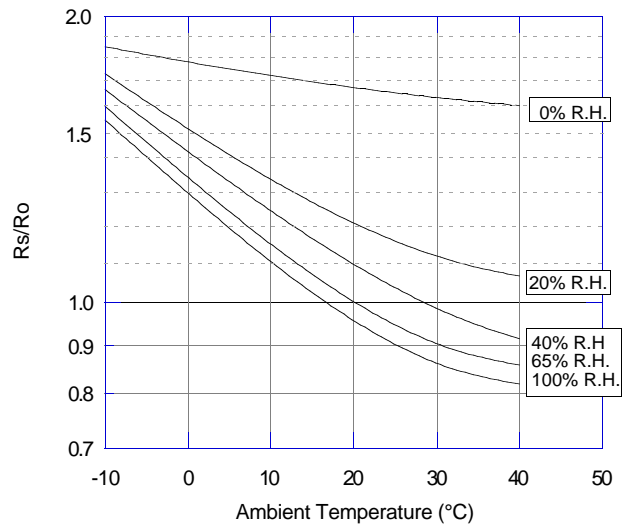

Fig. 6 - Temperature and humidity dependency (R_s/R_o)

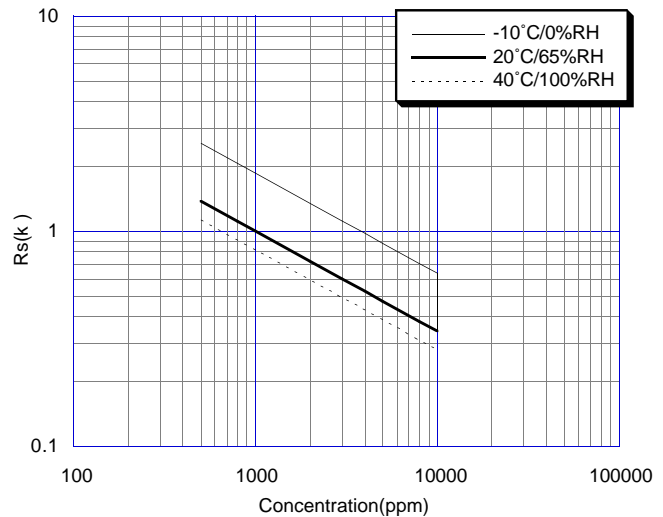

Fig. 7 - Resistance change ratio under various ambient conditions

2-3 Heater voltage dependency

Figure 8 shows the change in the sensor resistance ratio according to variations in the heater voltage (V_H).

Note that 5.0V as a heater voltage must be maintained because variance in applied heater voltage will cause the sensor's characteristics to be changed from the typical characteristics shown in this brochure.

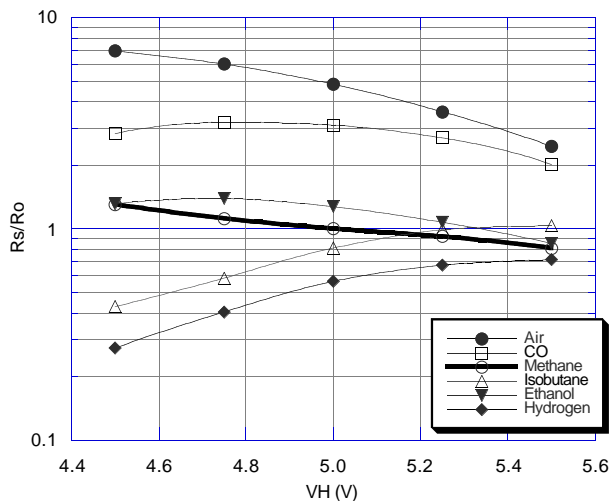

Fig. 8 - Heater voltage dependency
(Rs = Rs in 1000ppm of specified gas,
Ro = Rs at 1000ppm methane and V_H=5.0V)

2-4 Gas response

Figure 9 shows the change pattern of sensor resistance (Rs) when the sensor is inserted into and later removed from 1000ppm of methane.

As this chart displays, the sensor's response speed to the presence of gas is extremely quick, and when removed from gas, the sensor will recover back to its original value in a short period of time.

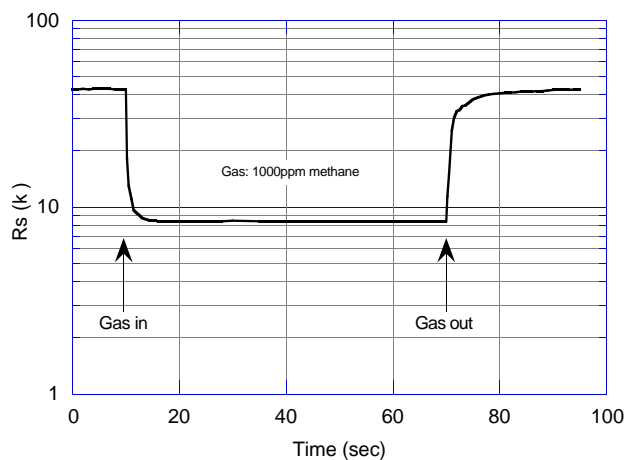

Fig. 9 - Response speed

Figure 10 demonstrates the sensor's repeatability by showing multiple exposures to a 1000ppm concentration of methane. The sensor shows good repeatability according to this data.

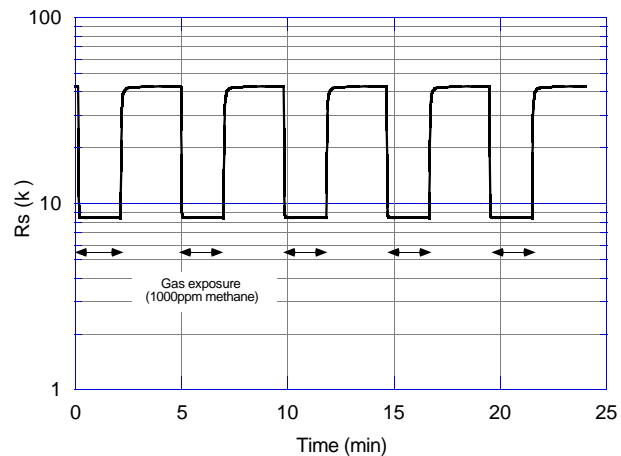

Fig. 10 - Repeatability

2-6 Initial action

Figure 11 shows the initial action of the sensor resistance (R_s) for a sensor which is stored unenergized in normal air for 30 days and later energized in clean air.

The R_s drops sharply for the first seconds after energizing, regardless of the presence of gases, and then reaches a stable level according to the ambient atmosphere. Such behavior during the warm-up process is called "Initial Action".

Since this 'initial action' may cause a detector to alarm unnecessarily during the initial moments after powering on, it is recommended that an initial delay circuit be incorporated into the detector's design (refer to Technical Advisory 'Technical Information on Usage of TGS Sensors for Toxic and Explosive Gas Leak Detectors'). This is especially recommended for intermittent-operating devices such as portable gas detectors.

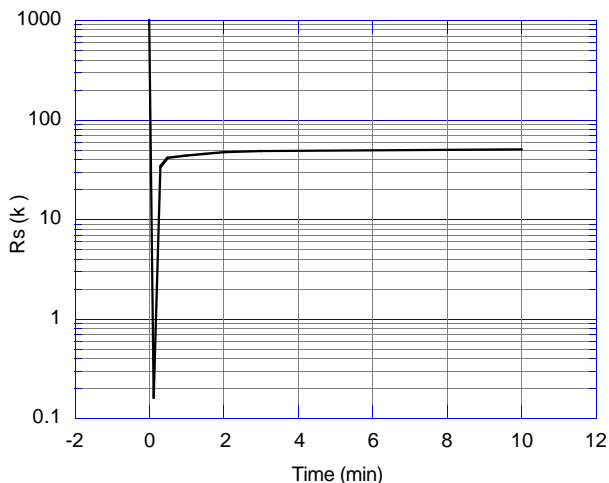

Fig. 11 - Initial action

2-7 Long-term characteristics

Figure 13 shows long-term stability of TGS813 as measured for more than 8 years. The sensor is first energized in normal air. Measurement for confirming sensor characteristics is conducted under ambient air conditions rather than in a temperature/humidity controlled environment. The cyclic change in sensitivity corresponds to the seasonal changes of temperature/humidity in Japan (peak T/H conditions occur in July, as corresponds with the sensitivity peaks in this chart). The Y-axis represents the ratio of sensor resistance in 1000ppm of methane on the date tested (R_s) to sensor resistance in 1000ppm of methane at the beginning of the test period (R_o).

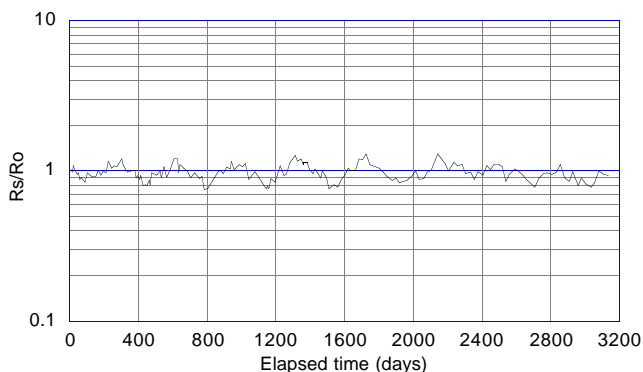

Fig. 12 - Long term stability
($R_o = R_s$ on day 1)

As this chart illustrates, TGS813 shows stable characteristics over a very long period of time.